

BRIGADE®

BE-865DDM vehicle CCTV monitor

User & fitting guide

User Guide & montage

User & Einbau Anleitung

Utente di montaggio e guida

Guía de usuario y montaje

User & montage handleiding



Stock code #3946



1 Contents

Contenu/Inhalt/Contenuti/Contenidos/inhoud

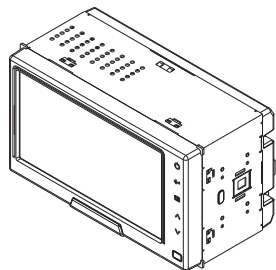

BE-865DD-M

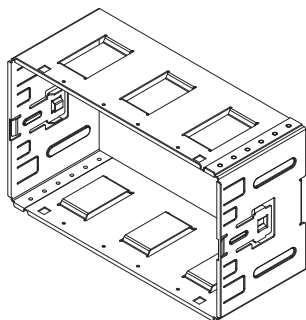

Trim Bracket

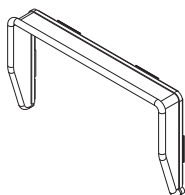

Sunvisor

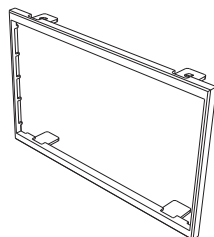

Deco plate

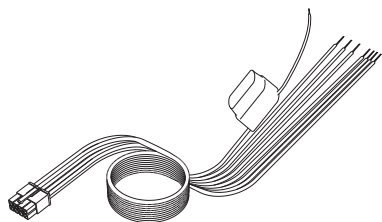

BE-865DDM-CA

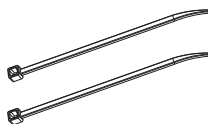

Cable tie (x2)

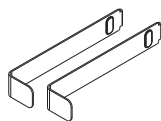

Release (x2)

Camera bracket



Self tapping screws



2 Monitor installation

Surveiller l'installation/Monitor-Installation/L'installazione del monitor/
Vigilar la instalación/Monitor installatie

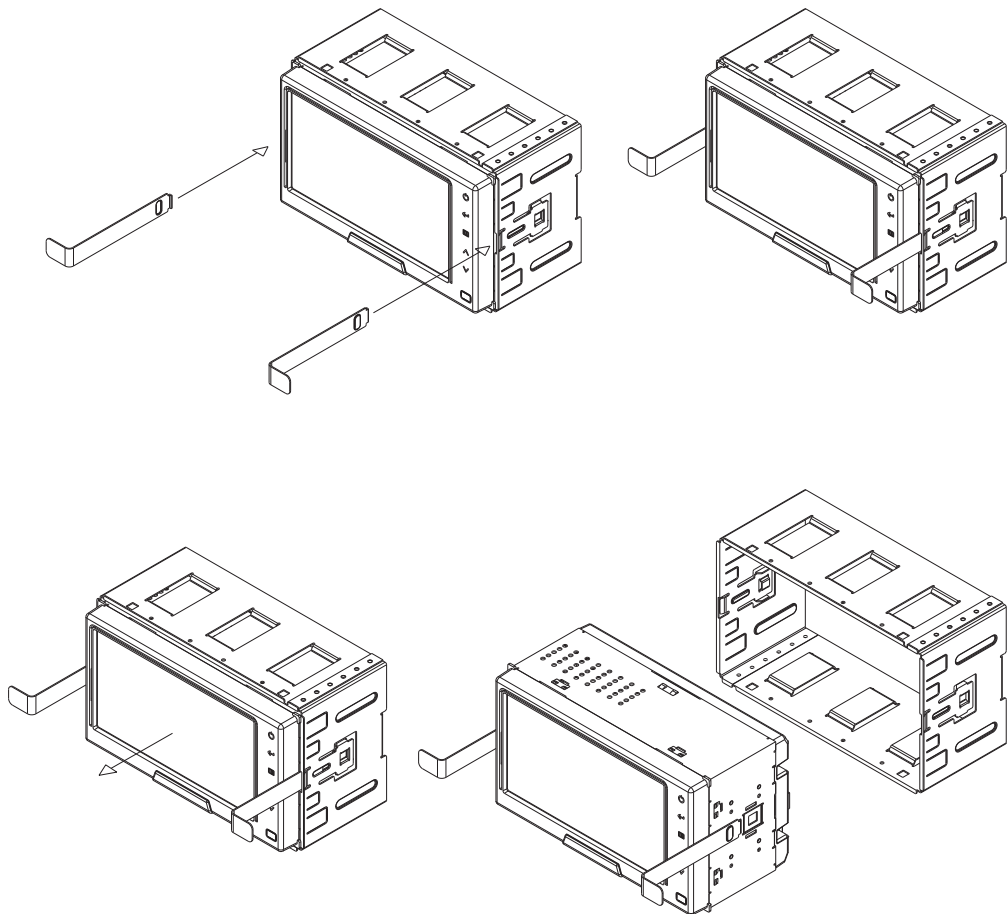

2 Monitor installation

Surveiller l'installation/Monitor-Installation/L'installazione del monitor/
Vigilar la instalación/Monitor installatie

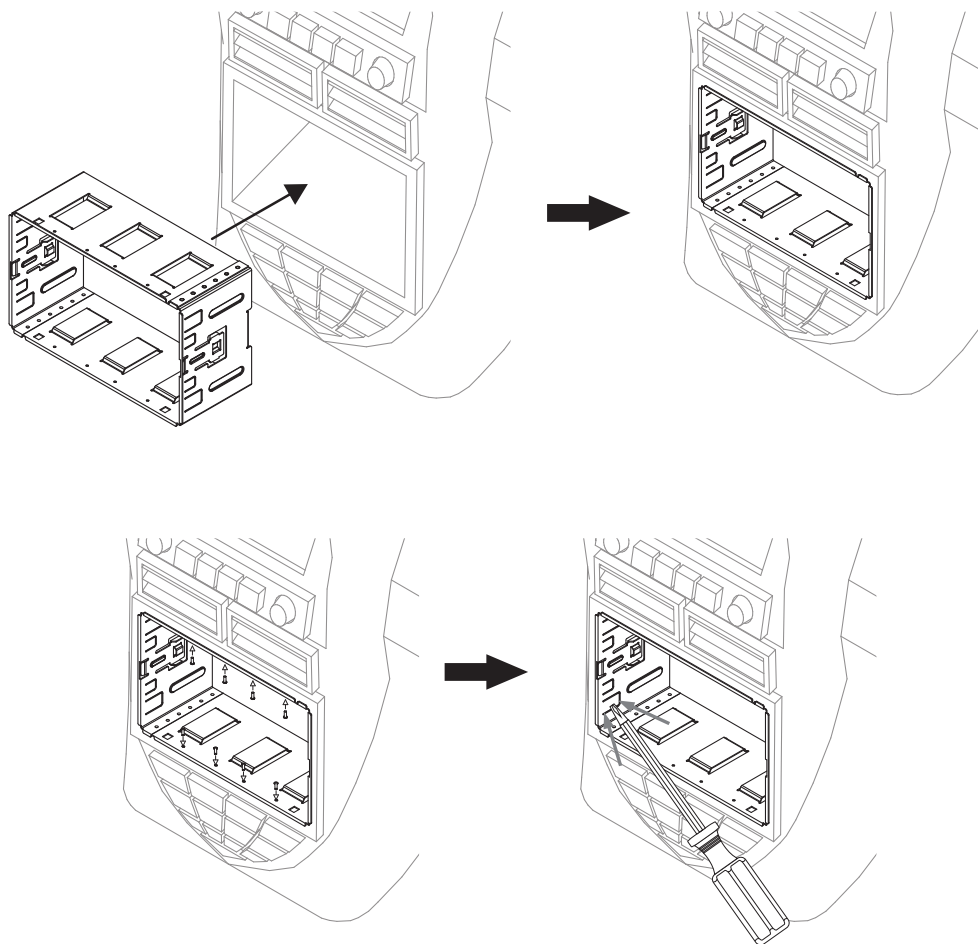

2 Monitor installation

Surveiller l'installation/ Monitor-Installation/ L'installazione del monitor/
Vigilar la instalación/ Monitor installatie

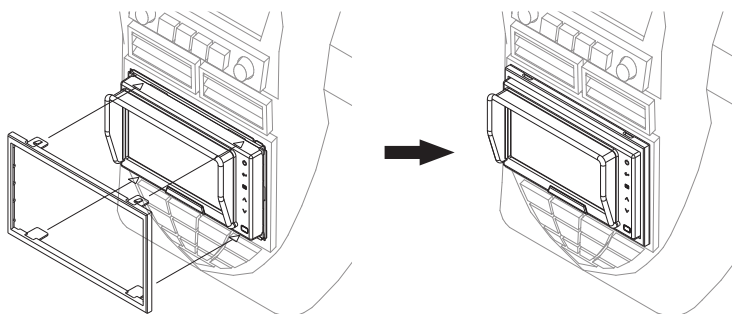
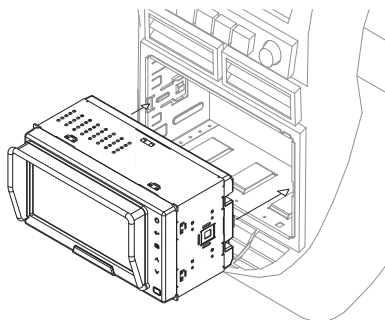
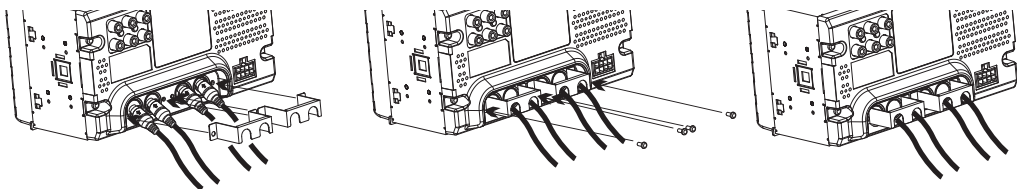
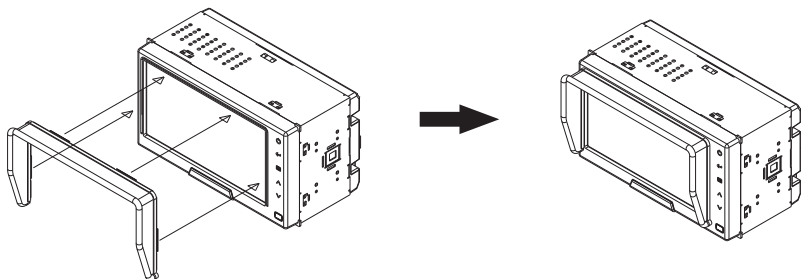

3 Connections

Connexions/Verbindungen/Connessioni/Conexiones/Aansluitingen

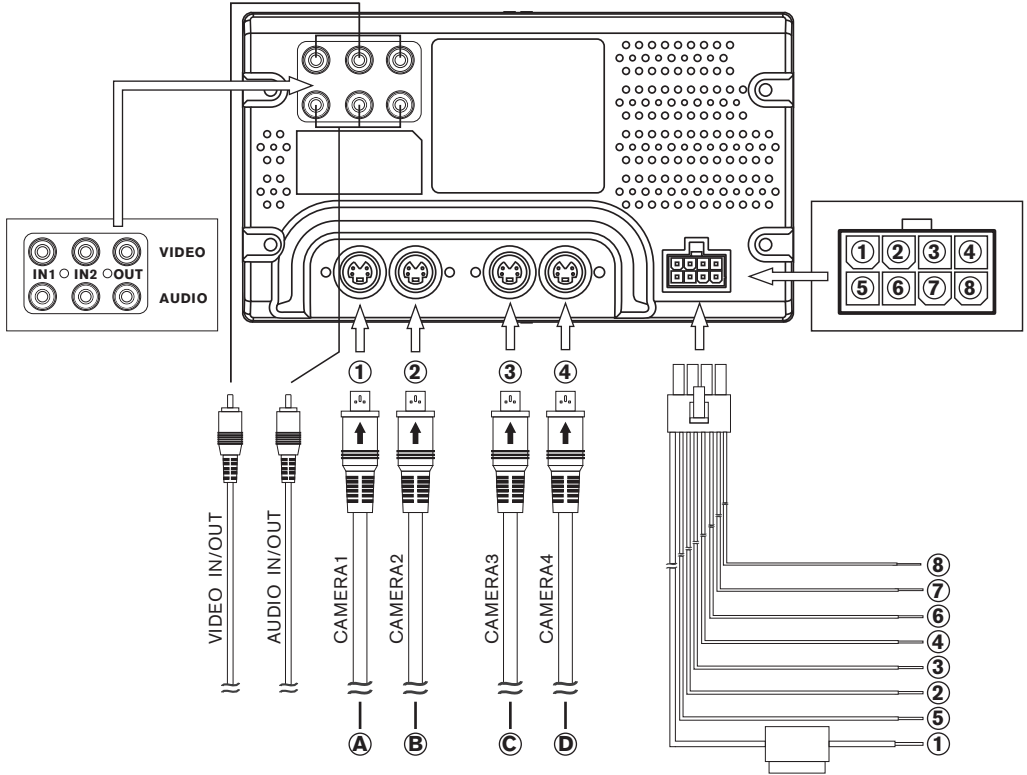

1 Red: Power
Rouge: Pouvoir
Rot: Macht
Rosso: Potenza
Rojo: Poder
Rood: Vermogen

2 Green: Trigger 1
Vert: Déclencher 1
Grün: Auslösen 1
Verde: Attivare 1
Verde: Desencadenar 1
Groen: Trekker 1

3 White: Trigger 2
Blanc: Déclencher 2
Weiß: Auslösen 2
Bianco: Attivare 2
Blanco: Desencadenar 2
Wit: Trekker 2

4 Brown: Trigger 5
Brunes: Déclencher 5
Braun: Auslösen 5
Marrone: Attivare 5
Marrón: Desencadenar 5
Bruin: Trekker 5

5 Black: Ground
Noir: Terre
Schwarz: Grund
Nero: Terreno
Negro: Terreno
Zwart: Grond

6 Yellow: Trigger 4
Jaunes: Déclencher 4
Gelb: Auslösen 4
Giallo: Attivare 4
Amarillo: Desencadenar 4
Geel: Trekker 4

7 Blue: Trigger 3
Bleu: Déclencher 3
Blau: Auslösen 3
Blu: Attivare 3
Azul: Desencadenar 3
Blauw: Trekker 3

8 Orange: Speed switch
Orange: Commutateur de vitesse
Orange: Drehzahlsschalter
Arançione: Velocità
Naranja: Interruptor de velocidad
Oranje: Speed-schakelaar

4 Controls

Contrôles/Kontrollen/Controlli/Controles/Controles

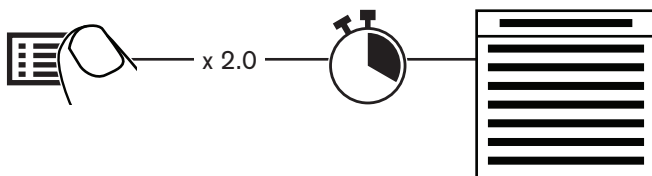
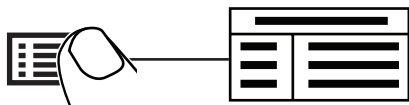
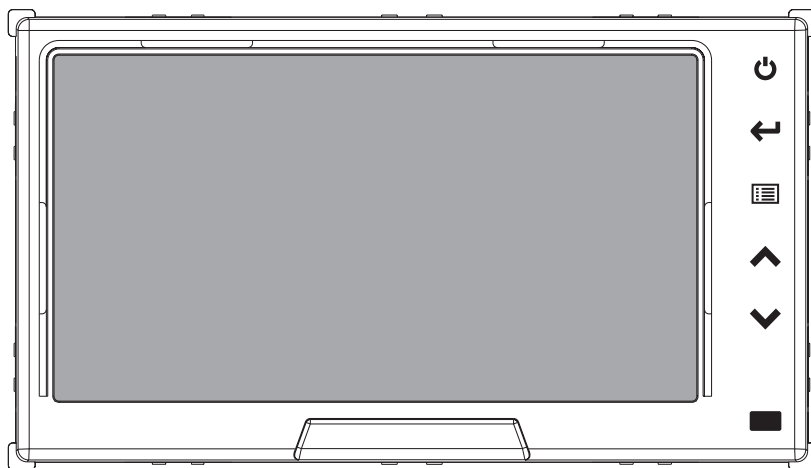

Automatic low light sensor - automatically adjusts monitor brightness.

Capteur optique automatique de basse luminosité - Réglage automatique de luminosité du moniteur.

Automatischer Low-Light Sensor -passt Monitorhelligkeit automatisch an.

Sensore automatico di bassa luminosità – varia automaticamente la luminosità dello schermo.

Sensor automático de baja luminosidad – adapta automáticamente la luminosidad del monitor.

Automatische low-light sensor – past de helderheid van de monitor automatisch aan.

5 Operation

Opération/Betrieb/Operazione/Operación/Werking

LANGUAGE SETTING

Réglage de la langue/Spracheinstellung/Impostazione lingua

Configuración de idioma/Taalinstelling

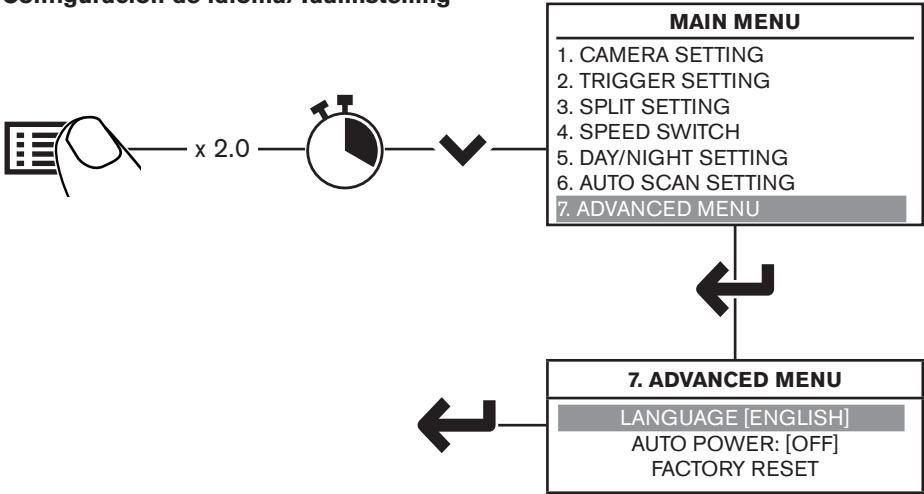

CAMERA SETTING

Réglage de la caméra/Kamera-Einstellung/Impostazione della fotocamera/

Ajustes de la cámara/De camera-instellingen

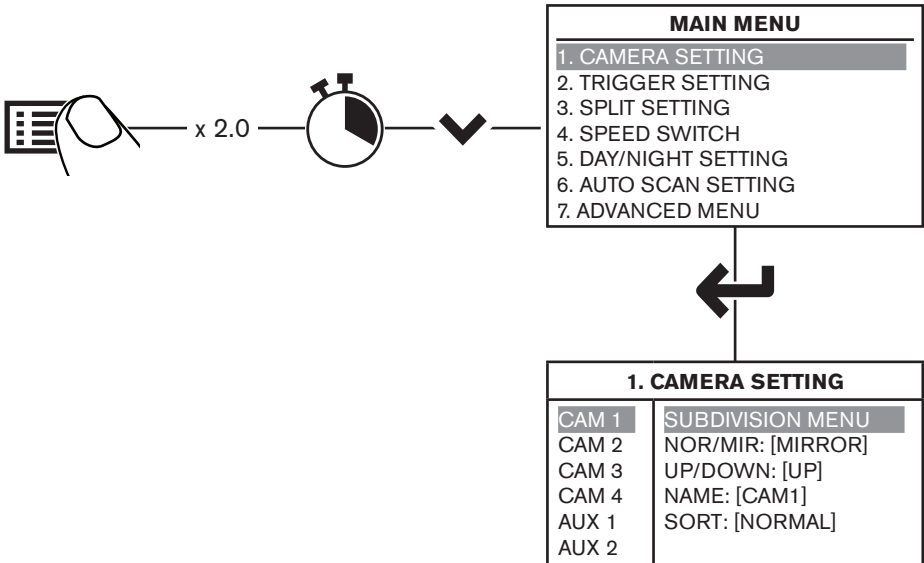

5 Operation

Opération/Betrieb/Operazione/Operación/Werking

Tilt camera setting (fix translation)

Réglage de balayage automatique/Auto-Scan-Einstellung/

Auto Scan impostazione/Configuración de escaneo automático/Auto Scan-instelling

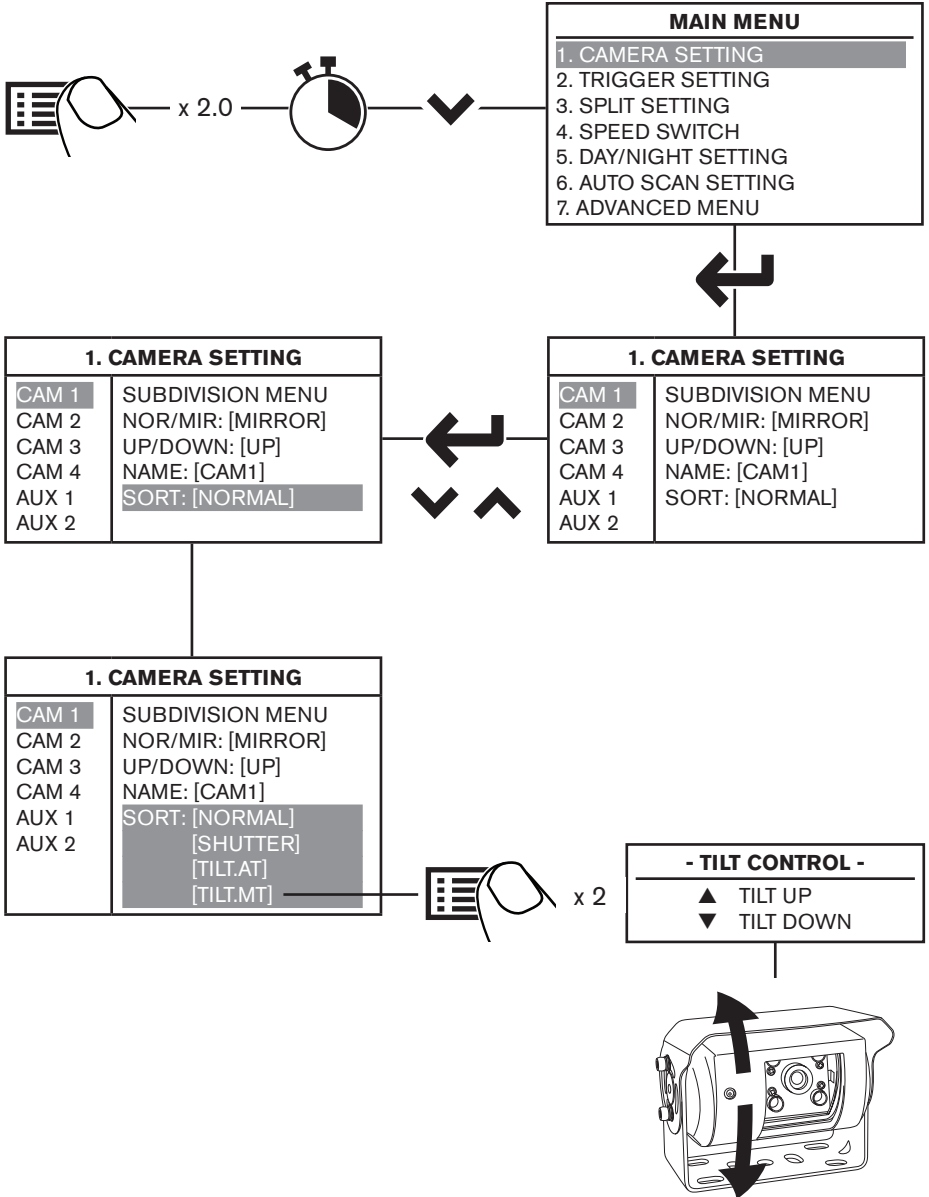

5 Operation

Opération/Betrieb/Operazione/Operación/Werking

TRIGGER SETTING

Paramètre de déclenchement/Trigger-Einstellung/Innescare impostazione/
Configuración de disparo/Drempelwaarde

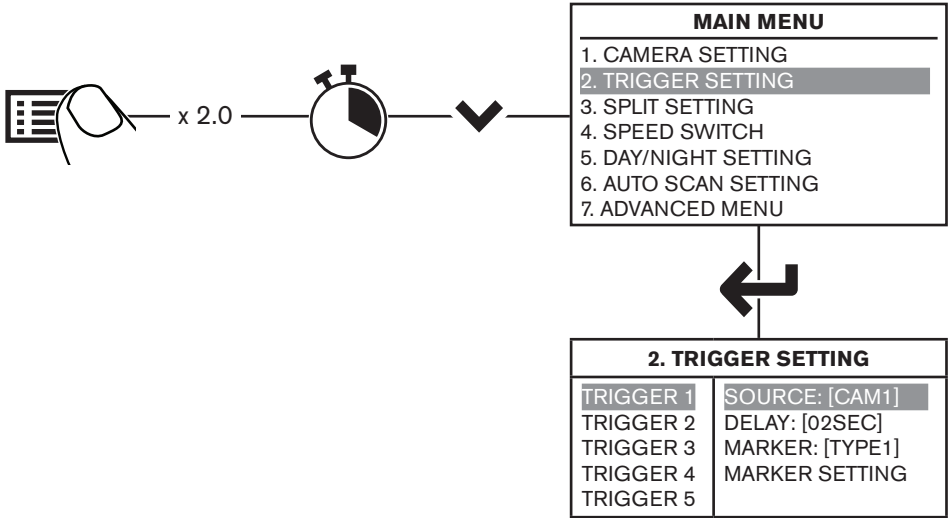

5 Operation

Opération/Betrieb/Operazione/Operación/Werking

SPLIT SETTING

Diviser réglage/Aufgeteilt Einstellung/Divisi impostazione/Dividir ajuste/Splitsen instelling

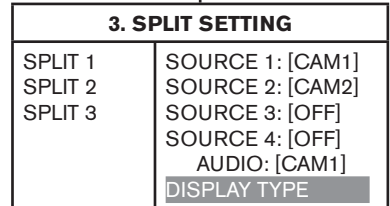
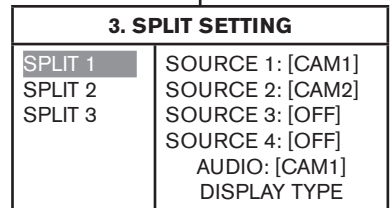
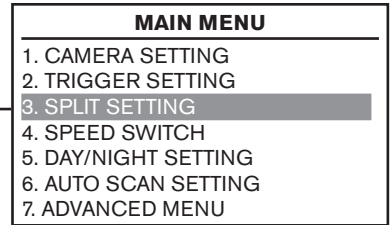
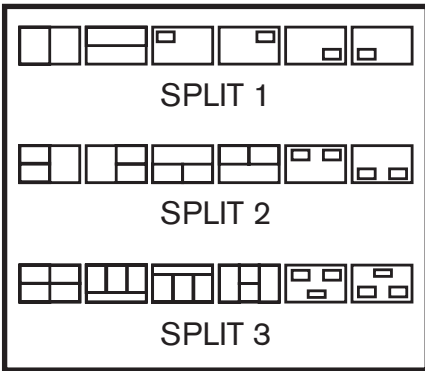
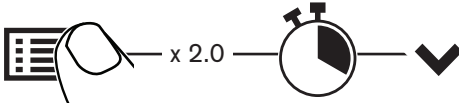

5 Operation

Opération/Betrieb/Operazione/Operación/Werking

MARKER SETTING

Mise en marqueur/Marker-Einstellung/Marker impostazione/
Marcador de ajuste/Marker instellin

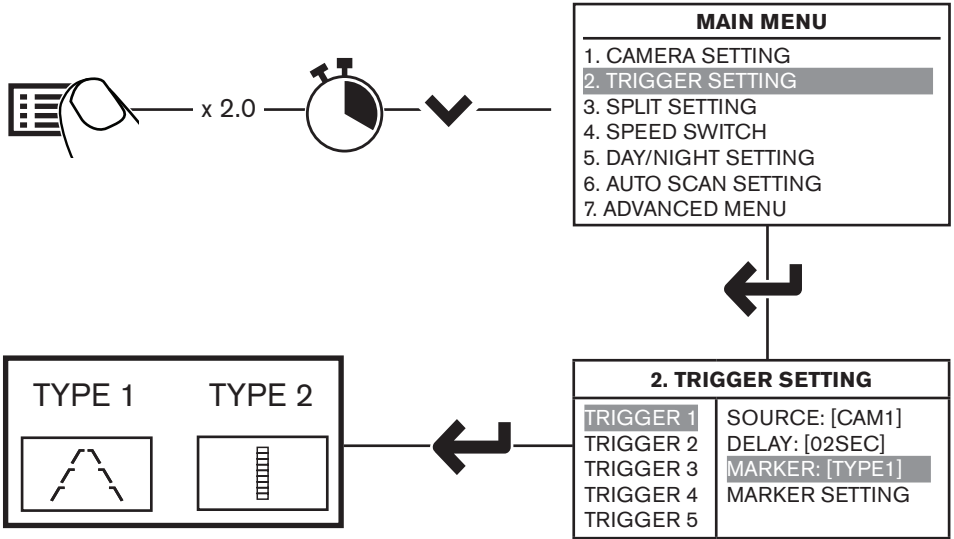

5 Operation

Opération/Betrieb/Operazione/Operación/Werking

MARKER SETTING

Mise en marqueur/Marker-Einstellung/Marker impostazione/
Marcador de ajuste/Marker instelling

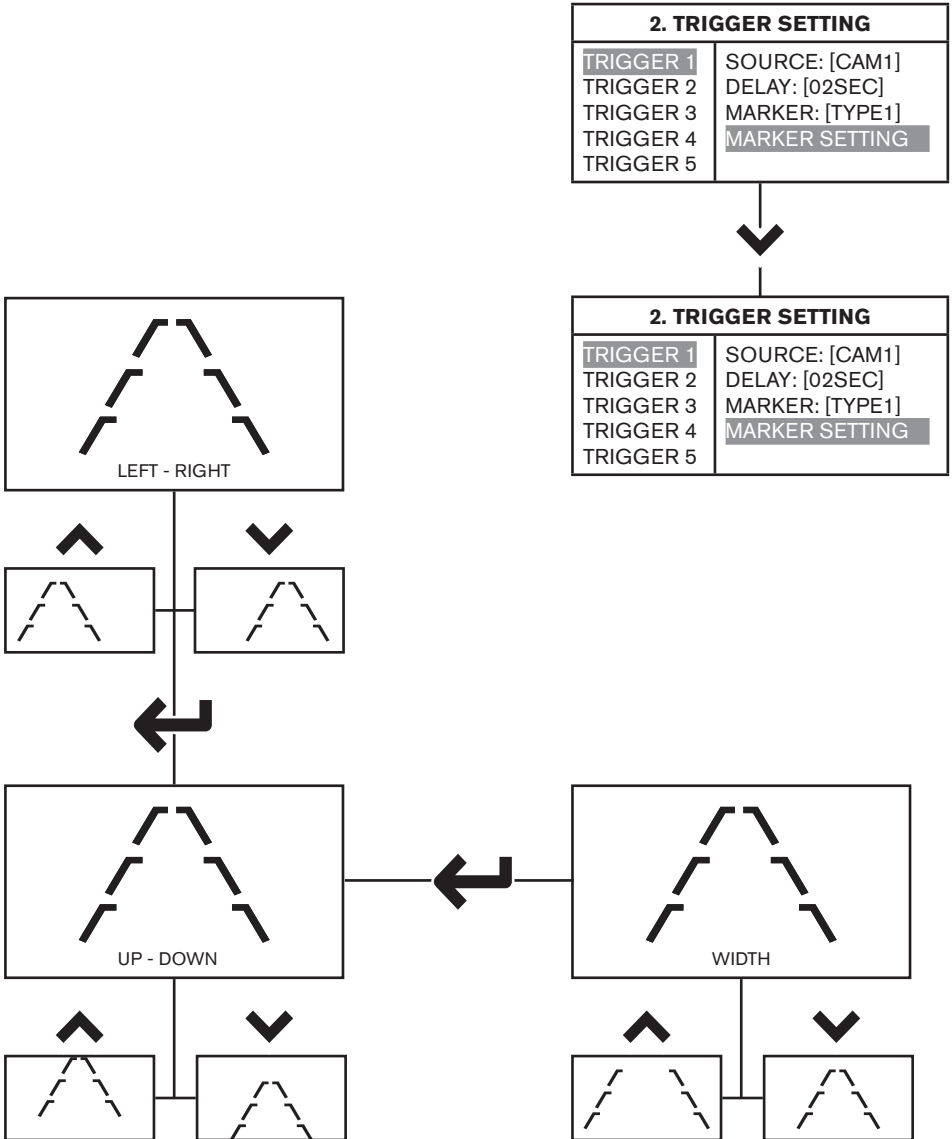

5 Operation

Opération/Betrieb/Operazione/Operación/Werking

SPEED SWITCH

Commutateur de vitesse/Drehzahlschalter/Commutatore di velocità/
Acelerar el cambio/Snelheid-schakelaar

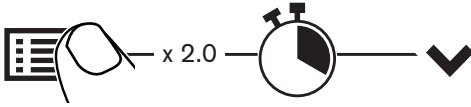

i.e. 1Km/h (0.62mph) = 2.21Hz \pm 5%
i.e. 33Km/h (20.5mph) = 69Hz \pm 5%

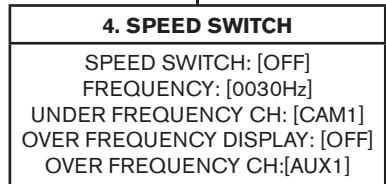
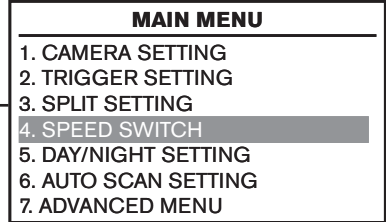

DAY/NIGHT SETTING

Jour / nuit réglage/Tag / Nacht-Einstellung/Giorno / notte impostazione/
Día / noche de ajuste/Dag / nacht-instelling

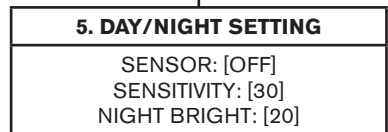
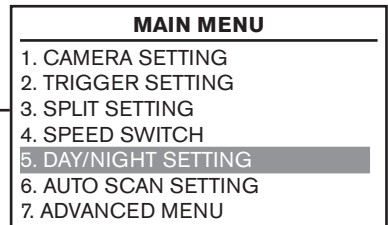
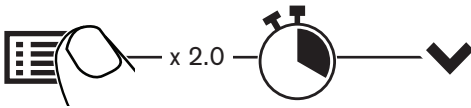

5 Operation

Opération/Betrieb/Operazione/Operación/Werking

AUTO SCAN SETTING

Réglage de balayage automatique/Auto-Scan-Einstellung/

Auto Scan impostazione/Configuración de escaneo automático/Auto Scan-instelling

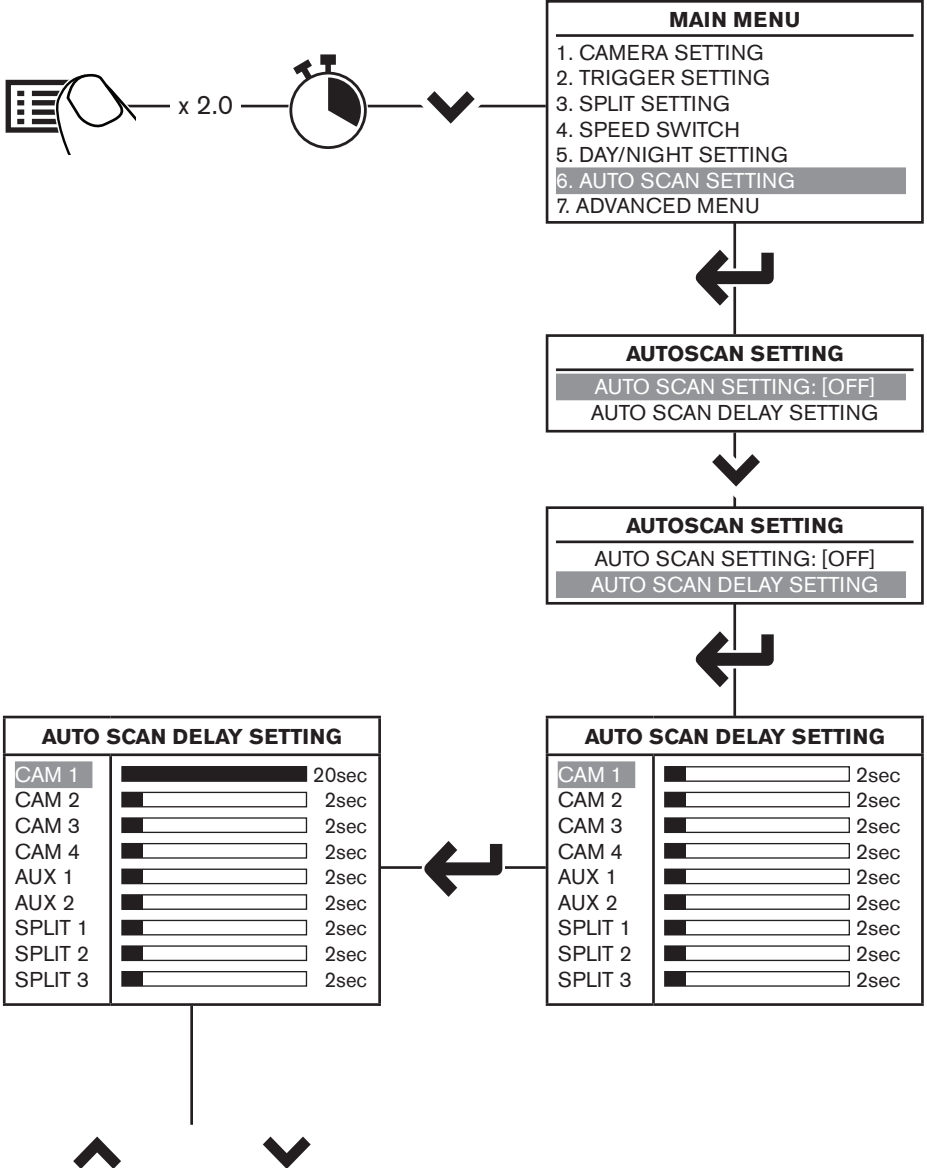

5 Operation

Opération/Betrieb/Operazione/Operación/Werking

BUTTON LOCK

Bouton de verrouillage/Tastensperre/Pulsante di blocco/Botón de bloqueo/
Knopvergrendeling

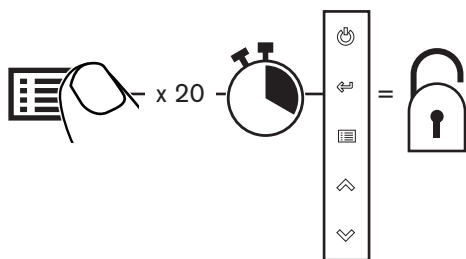
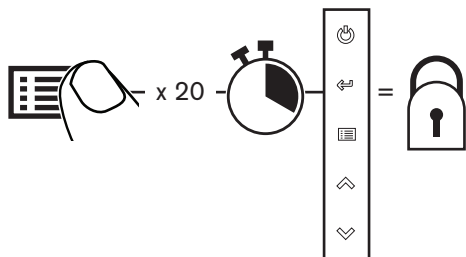

6 Specifications

Spécifications/ Spezifikationen/Specifiche/Especificaciones/Specificaties

ENGLISH	
Specifications	
Monitor	BE-865DDM
TV system	NTSC/PAL
Picture	6.5" TFT LCD colour monitor with on-screen display function
Display size	6.5" diagonal
Field of view	Top: 50°, Bottom: 70°, Left: 70°, Right: 70°
Resolution	800 x 3 (RGB) x 480
Picture image	Factory set to reverse image
Power	12~24Vdc input
Inputs	4 x camera - 2 x AV
Dimensions	187,9(w) x 115,6(h) x 142,4(d)mm 7,4(w) x 4,5(h) x 5,6(d) inches
Operating temperature	-40°C ~ +70°C -40°F ~ +158°F

FRANCAIS	
Specifications	
Moniteur	BE-865DDM
Système TV	NTSC/PAL
Image	6,5" TFT LCD moniteur couleur avec affichage de fonction
Dimension de l'ecran	6,5" diagonal
Champ de vision	Haut: 50°, Bas: 70°, Gauche: 70°, Droite: 70°
Résolution	800 x 3 (RGB) x 480
Image vidéo	Réglage d'usine sur image inverse
Alimentation	12~24Vdc input
Entrées	4 x caméra - 2 x AV
Dimensions	187,9(w) x 115,6(h) x 142,4(d)mm 7,4(w) x 4,5(h) x 5,6(d) inches
Température d'utilisation	-40°C ~ +70°C -40°F ~ +158°F

ITALIANO	
Specifiche	
Schermo	BE-865DDM
Sistema TV	NTSC/PAL
Immagine	6,5 "TFT LCD a colori con on-screen funzione di visualizzazione
Formato display	6.5" diagonale
Campo visivo	Top: 50°, Fondo: 70°, Sinistra: 70°, Destra: 70°
Risoluzione	800 x 3 (RGB) x 480
Immagine a video	Immagine reversibile programmabile
Alimentazione	12~24Vdc input
Prese	4 x telecamera - 2 x AV
Dimensioni	187,9(w) x 115,6(h) x 142,4(d)mm 7,4(w) x 4,5(h) x 5,6(d) inches
Temperatura di servizio	-40°C ~ +70°C -40°F ~ +158°F

DEUTSCH	
Spezifikationen	
Monitor	BE-865DDM
TV-System	NTSC/PAL
Bild	6.5" TFT LCD Farbmonitor mit Funktionsanzeige
Bildschirmgröße	6.5" diagonal
Sichtfeld	Oben: 50°, Unten: 70°, Links: 70°, Rechts: 70°
Auflösung	800 x 3 (RGB) x 480
Videobild	Werkseinstellung Reversebild
Stromversorgung	12~24Vdc input
Eingänge	4 x kamera - 2 x AV
Abmessungen	187,9(w) x 115,6(h) x 142,4(d)mm 7,4(w) x 4,5(h) x 5,6(d) inches
Betriebstemperatur	-40°C ~ +70°C -40°F ~ +158°F

Specifications subject to change. Sous réserve de modifications techniques. Vorbehaltlich technischer Änderungen. Con riserva di modifiche tecniche. Reservadas las modificaciones técnicas. Technische wijzigingen voorbehouden.

6 Specifications

Spécifications/ Spezifikationen/ Specifiche/ Especificaciones/ Specificaties

ESPAÑOL	
Especificaciones	
Monitor	BE-865DDM
Sistema de TV	NTSC/PAL
Imagen	Monitor a color de 6.5" TFT LCD con visualización de las funciones
Tamaño de pantalla	6.5" diagonal
Campo visual	arriba: 50°, abajo: 70°, a la izquierda: 70°, a la derecha: 70°
Resolución	800 x 3 (RGB) x 480
Imagen de vídeo	Ajuste de fábrica de la imagen inversa
Suministro de corriente	12~24Vdc entrada
Entradas	4 x cámara - 2 x AV
Dimensiones	187,9(w) x 115,6(h) x 142,4(d)mm 7,4(w) x 4,5(h) x 5,6(d) inches
Temperatura de servicio	-40°C ~ +70°C -40°F ~ +158°F

NEDERLANDS	
Specificaties	
Monitor	BE-865DDM
TV-systeem	NTSC/PAL
Beeld	6,5 "TFT LCD kleurenmonitor met on-screen display functie
Displayformaat	6.5" diagonaal
Gezichtsveld	Boven: 50°, Onder: 70°, Links: 70°, Rechts: 70°
Resolutie	800 x 3 (RGB) x 480
Videobeeld	Fabrieksinstelling reversebeeld
Stroomvoorziening	12~24Vdc Ingang
Ingangen	4 x camera - 2 x AV
Afmetingen	187,9(w) x 115,6(h) x 142,4(d)mm 7,4(w) x 4,5(h) x 5,6(d) inches
Bedrijfstemperatuur	-40°C ~ +70°C -40°F ~ +158°F

Specifications subject to change. Sous réserve de modifications techniques. Vorbehaltlich technischer Änderungen. Con riserva di modifiche tecniche. Reservadas las modificaciones técnicas. Technische wijzigingen voorbehouden.

Disclaimer

Camera monitor systems are an invaluable driver aid but do not exempt the driver from taking every normal precaution when conducting a manoeuvre. No liability arising out of the use or failure of the product can in any way be attached to Brigade or to the distributor.

Dénégation

Les systèmes de moniteurs des caméras sont une aide précieuse pour le conducteur, mais celui-ci doit toutefois prendre toutes les précautions nécessaires pendant les manœuvres. Brigade ou ses distributeurs n'assument aucune responsabilité résultant de l'utilisation ou d'un défaut du produit.

Verzichterklärung

Die Kamerabildschirmssysteme sind eine wertvolle Hilfe für den Fahrer, entbinden ihn jedoch nicht von der notwendigen Sorgfalt beim Manövrieren des Fahrzeuges. Brigade und seine Vertriebshändler haften nicht für Schäden aus der Nutzung oder einer Fehlfunktion des Produktes.

Disconoscimento

I sistemi di monitor della telecamera sono un aiuto prezioso per il conduttore, ma non lo esonerano dall'obbligo di prendere le precauzioni necessarie durante le manovre del veicolo. Bridage e i suoi distributori non si assumono nessuna responsabilità per danni risultanti dall'utilizzo o da un malfunzionamento del prodotto.

Negante

Los sistemas de pantalla de cámara son una valiosa ayuda destinada a los conductores; en todo caso no les resta la responsabilidad de proceder con precaución a la hora de maniobrar con el vehículo. Brigade y sus distribuidores comerciales no se responsabilizan de los daños derivados de un mal funcionamiento del producto.

Verwerping

De camera-monitorsystemen zijn een waardevolle hulp voor de bestuurder, ontheffen hem echter niet van de nodige zorgvuldigheid bij het manoeuvreren van het voertuig. Brigade en zijn distributeurs zijn niet aansprakelijk voor schade door gebruik of een gebrek van het product.

Serial No:

Stock code:



www.brigade-electronics.com

